

# Cold Rooms

# Celle Frigorifere



REF. 0920



**cold mark**  
INSULATED PANELS

**FIXWELL**  
[www.fixwell.com.hk](http://www.fixwell.com.hk)



## Un prodotto garantito da un'elevata tecnologia e dalla qualità dei materiali

Cold Mark nasce nel 2003 come distaccamento del gruppo Everlasting s.r.l. specializzato nella produzione di celle frigorifere componibili. L'utilizzo di materiali di alta qualità, la semplicità e rapidità di montaggio e il rispetto delle normative igienico sanitarie e ambientali, rendono le celle ColdMark un prodotto affidabile e performante capace di soddisfare diverse esigenze di conservazione e stoccaggio.

Le celle Mini Box, Hyper Box e Maxi Cab sono ideali per ristoranti, pizzerie, hotel, mense, ospedali, laboratori chimici e farmaceutici, supermercati, magazzini alimentari, magazzini ortofrutta, laboratori di gelaterie e pasticcerie, impianti di macellazione, industria lattiero casearia, magazzini di stagionatura, e per ogni esigenza nella refrigerazione professionale.



## **A product guaranteed by high technology and quality of the materials**

Cold Mark was born in 2003 as a branch of Everlasting s.r.l Group specialised in the production of modular refrigeration cold rooms. The use of high quality materials, the quick and easy assemble and the compliance with sanitary and environmental hygiene regulations, make the Cold Mark cold rooms a reliable and efficient product able to respond to every needs of storage and conservation.

Mini Box, Hyper Box and Maxi Cab cold rooms are the ideal products for restaurants, pizzerias, hotels, canteens, hospitals, chemical and pharmaceutical laboratories, supermarkets, grocery warehouses, fruit and vegetable warehouses, ice-cream and pastry workshops, slaughter plants, dairy industry, seasoning warehouses.

# MINI BOX





## CELLE COMPONENTI IN KIT DI MONTAGGIO

Rapidità e semplicità di montaggio  
Razionale utilizzo degli spazi interni  
Qualità dei materiali  
Sempre disponibili a magazzino

## ASSEMBLY KIT MODULAR COLD ROOMS

Quick and easy installation  
Rational usage of internal space  
Quality of employed materials  
Always available on stock



## CARATTERISTICHE TECNICHE

- Spessore unico 8 cm per temperatura positiva (TN) e negativa (BT)
- Altezza: esterna 208 cm, interna 192 cm
- Rivestimento interno/esterno in lamiera zinco-plastificata di colore bianco
- Angoli interni arrotondati
- Isolamento in poliuretano ecologico ad alta densità 40 - 42 Kg/m<sup>3</sup>
- Pavimento in lamiera zinco-plastificata antiscivolo di colore grigio
- Porta standard su cerniere con luce netta 70×190h cm dotata di chiusura a chiave
- Scaffalatura in alluminio certificata per alimenti con piani in polietilene
- Gruppi frigoriferi a monoblocco, split o remoti



## TECHNICAL FEATURES

- 8 cm single thickness for positive (TN) and negative (BT) temperature
- Height: external 208 cm, internal 192 cm
- Internal/external covering in white plastic-coated galvanized sheet
- Internal rounded corners
- Insulation by environment-friendly polyurethane with high density 40 - 42 Kg/m<sup>3</sup>
- Floor in grey non-slip plastic-coated galvanized sheet
- Standard hinged door with net passage 70×190h and key-lock
- Food-grade aluminium shelves with polyethylene tiers
- Monoblock, split or remote refrigerating units



Maniglia con serratura  
Handle with key-lock



Sblocco di sicurezza interno  
Internal safety release



Pavimento con gradino di contenimento arrotondato  
Floor perimeter with rounded frame step



Possibilità di montaggio unità monoblocco a parete  
- a soffitto - remoto  
Possibility of installing wall-mounted,  
ceiling-mounted or remote refrigerating unit



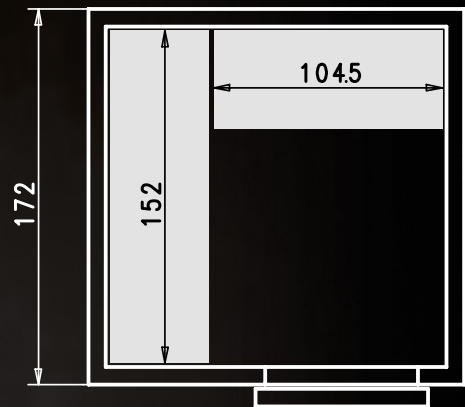
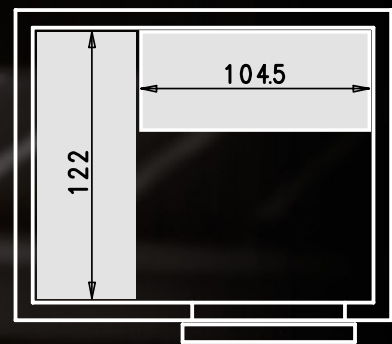
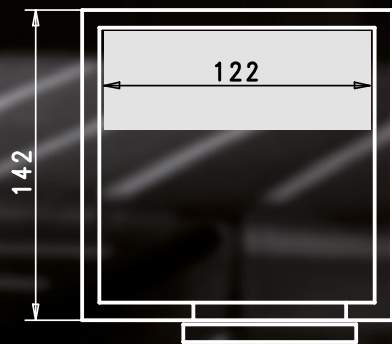
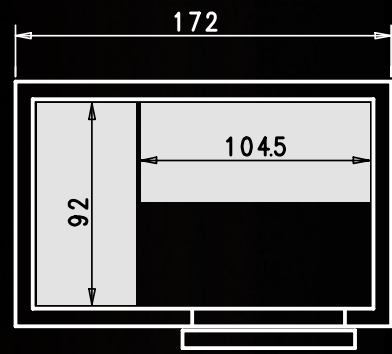
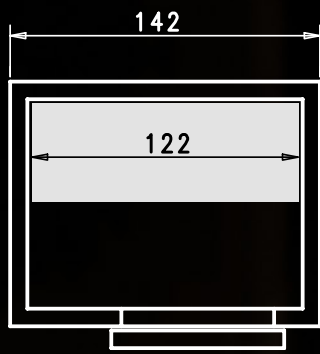
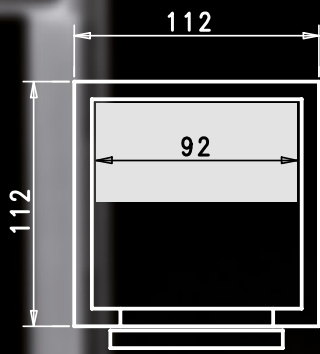

### SCAFFALATURA

- Materiale: alluminio e polietilene
- Dimensioni: P 45 x H 170 cm - 4 ripiani

### SHELVES

- Materials: aluminium and polyethylene
- Dimensions: D 45 x H 170 cm - 4 tiers

Scaffalature disponibili come optional.  
Shelves are available as an optional.





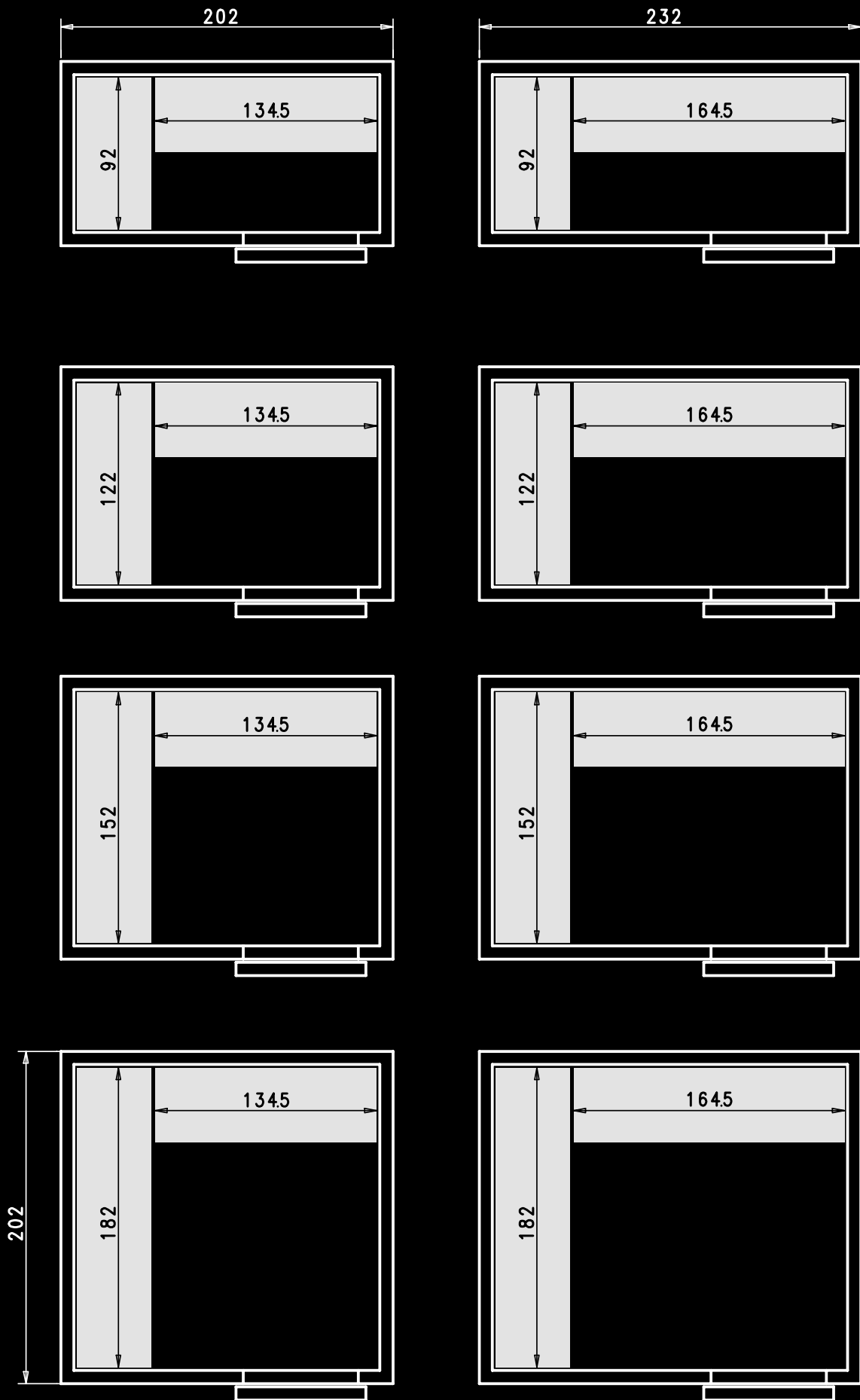

COMPOSIZIONE CELLE CON SCAFFALATURE  
LAYOUT OF COLD ROOMS WITH SHELVES

# HYPER BOX





## **MODULARITA'**

Funzionale ottimizzazione degli spazi.

## **DESIGN**

Estetica elegante e raffinata.

## **QUALITA'**

Utilizzo di materiali di alta qualità.

## **PRATICITA'**

Montaggio semplice e rapido.

## **CONFORMITA'**

Rispetto degli standard igienico-ambientali.

## **MODULARITY**

Functional space optimization

## **DESIGN**

Elegant and refined design.

## **QUALITY**

Use of high quality materials.

## **CONVENIENCE**

Easy and quick installation.

## **COMPLIANCE**

Compliance with hygienic and environmental standards.



[www.fixwell.com.hk](http://www.fixwell.com.hk)

# HYPER BOX

## CARATTERISTICHE TECNICHE

- 4 spessori disponibili: 7 , 10 , 12 e 15 cm
- 6 altezze interne standard: da 202 a 382 cm
- Possibilità di suddivisioni interne con divisori fissi agganciati o con profili in pvc avvitati
- Rivestimento interno/esterno in lamiera zinco-plastificata di colore bianco
- Angoli interni arrotondati
- Isolamento in poliuretano ecologico ad alta densità 40 - 42 Kg/m<sup>3</sup>
- Pavimento in lamiera zinco-plastificata antiscivolo di colore grigio con rinforzo in legno
- Porta standard con luce netta 80×190 h cm dotata di chiusura a chiave
- Porte su cerniere con luce netta 70×190 h cm , 90×190 h cm , 100×200 h cm (a richiesta)
- Porte su telaio a battente o scorrevoli (a richiesta)
- Rivestimento in acciaio inox (a richiesta)
- Gruppi frigoriferi a monoblocco, split o remoti (a richiesta)

## TECHNICAL FEATURES

- 4 available thicknesses, 7, 10, 12 and 15 cm
- 6 internal standard heights from 202 to 382 cm
- Possibility of creating internal compartments either with fixed hooked partitions or screwed PVC profiles partitions
- Internal/external covering in white plastic-coated galvanized sheet
- Internal rounded corners
- Insulation by environment-friendly polyurethane with high density 40 - 42 Kg/m<sup>3</sup>
- Floor in grey antislip plastic-coated galvanized sheet with wood reinforcement
- Standard door with net passage 80×190 h cm and key lock
- Hinged doors with net passage 70×190 h cm, 90×190 h cm and 100×200 h cm on demand
- Hinged doors with frame or sliding on demand
- Stainless steel covering on demand
- Monoblock, split or remote refrigerating units (on demand)

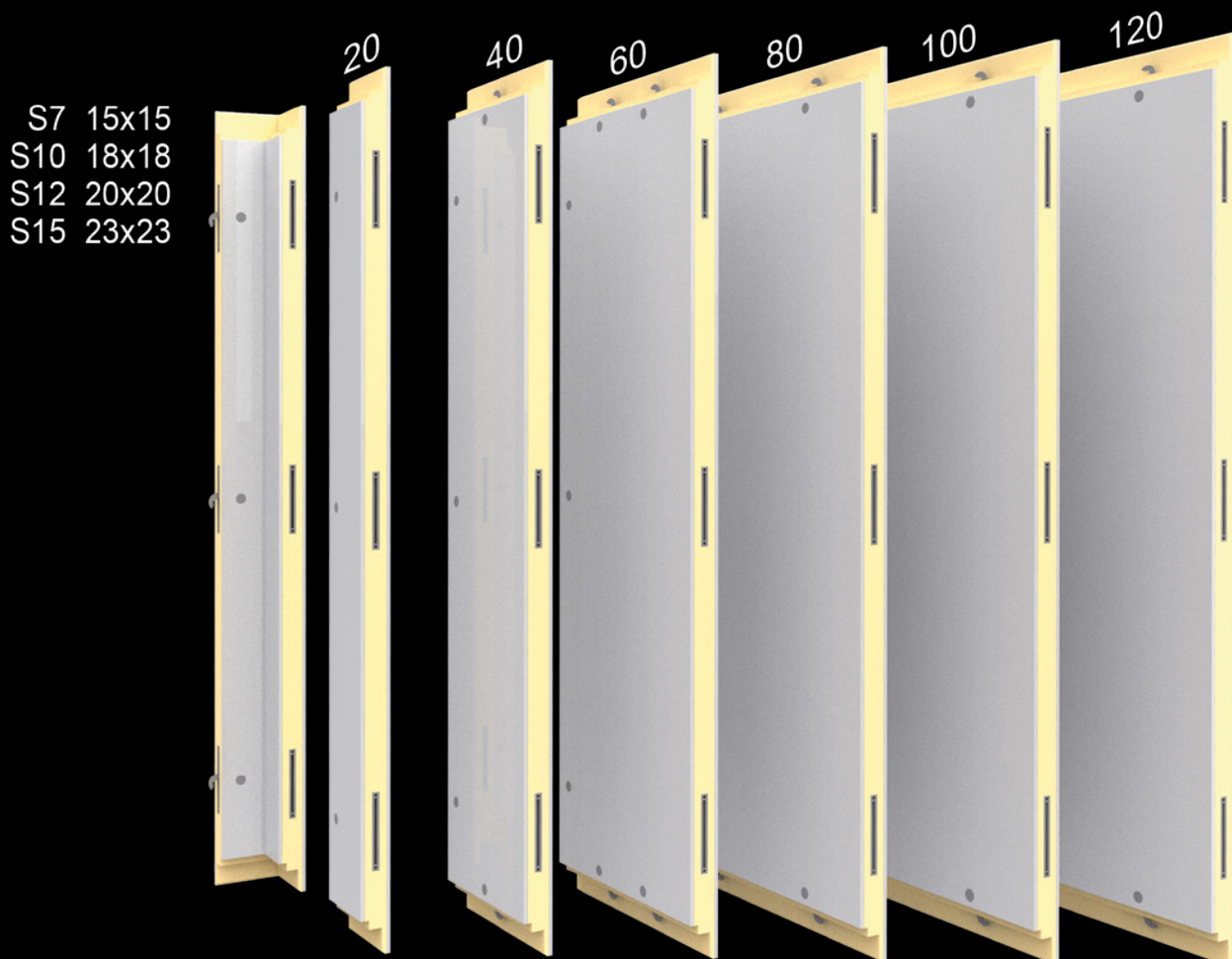

# ALTEZZE PANNELLI - PANELS HEIGHTS

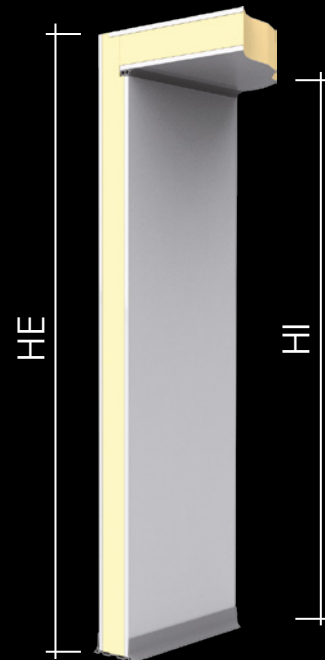
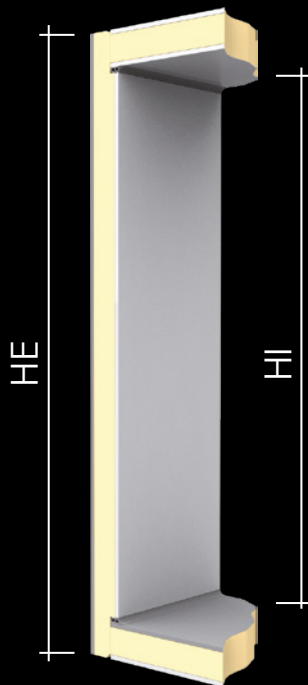

ALTEZZE - HEIGHTS (cm)

Con pavimento - With floor

|     | S7  | S10 | S12 | S15 |
|-----|-----|-----|-----|-----|
| HI  | HE  | HE  | HE  | HE  |
| 202 | 216 | 222 | 226 | 232 |
| 222 | 236 | 242 | 246 | 252 |
| 242 | 256 | 262 | 266 | 272 |
| 282 | 296 | 302 | 306 | 312 |
| 322 | 336 | 342 | 346 | 352 |
| 382 | 396 | 402 | 406 | 412 |

ALTEZZE - HEIGHTS (cm)

Senza pavimento - Without floor

|     | S7  | S10 | S12 |
|-----|-----|-----|-----|
| HI  | HE  | HE  | HE  |
| 202 | 209 | 212 | 214 |
| 222 | 229 | 232 | 234 |
| 242 | 249 | 252 | 254 |
| 282 | 289 | 292 | 294 |
| 322 | 329 | 332 | 334 |
| 382 | 389 | 392 | 394 |

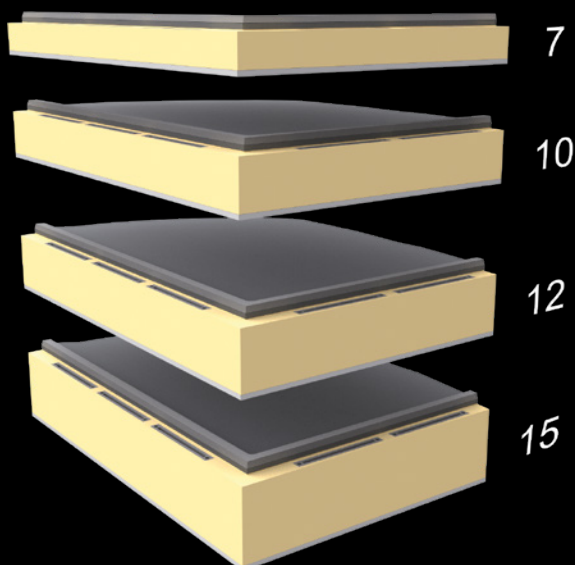

Spessori di isolamento  
Insulation thickness





**DAL PROGETTO ALLA REALIZZAZIONE  
FROM PLANNING TO REALIZATION**

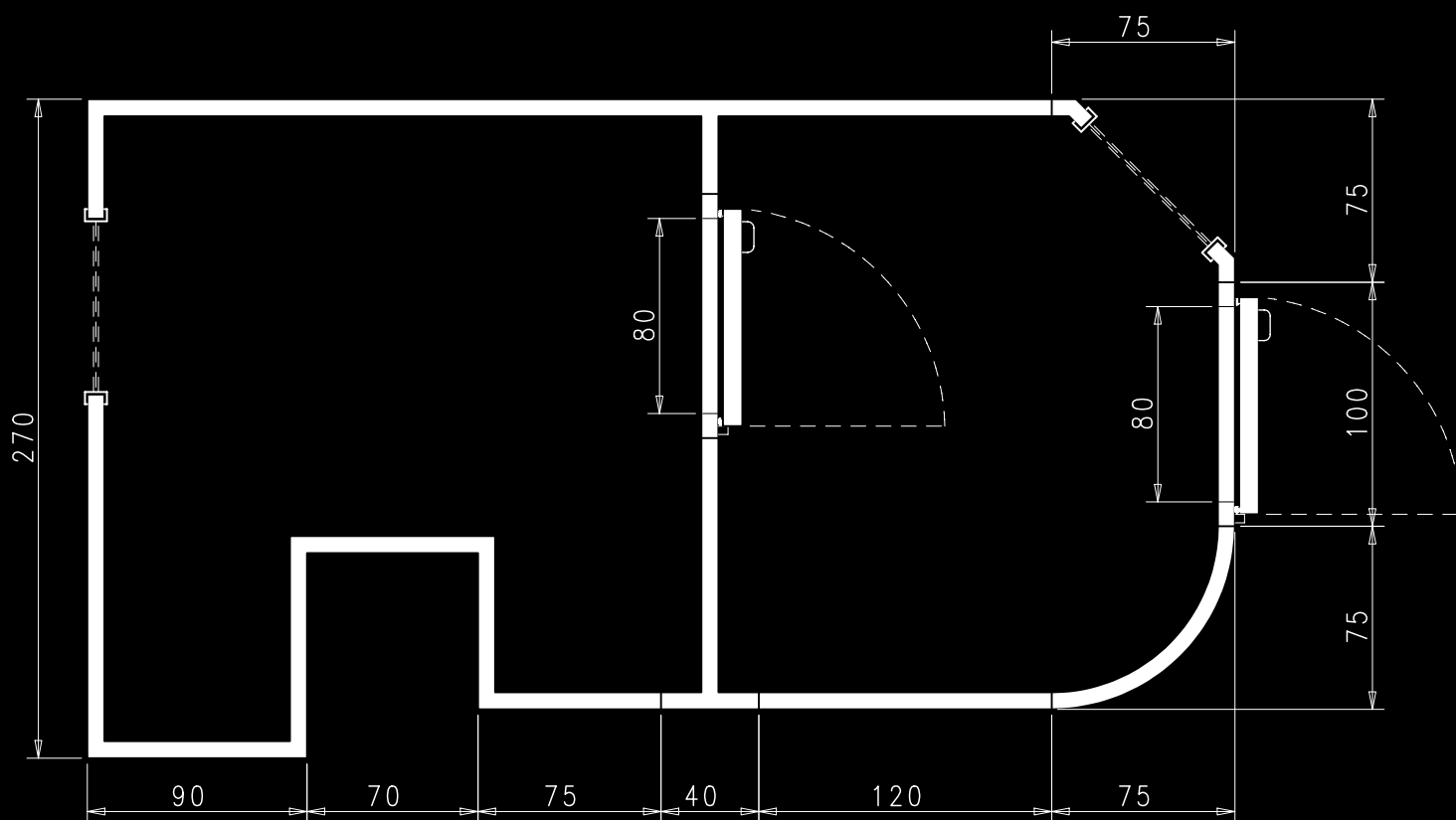

### **LA TUA CELLA SU MISURA**

Gestione di layout complessi e articolati grazie alla modularità dei pannelli a passo 20 cm.  
Possibilità di realizzare pannelli speciali per creare celle totalmente su misura.  
La realizzazione a pannelli totalmente "agganciati" evita complicate modifiche sul luogo di montaggio.

### **YOUR CUSTOM-MADE COLD ROOM**

Management of complex and structured layouts thanks to our 20 cm panel modularity.  
Possibility of producing special panels to create totally custom-made cold rooms.  
Our totally "hooked" panels avoid tiresome and challenging modifications on the installation site.

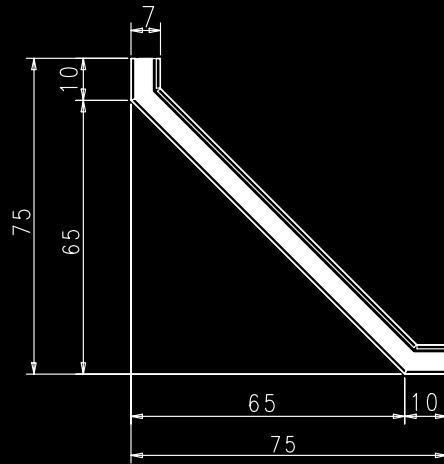
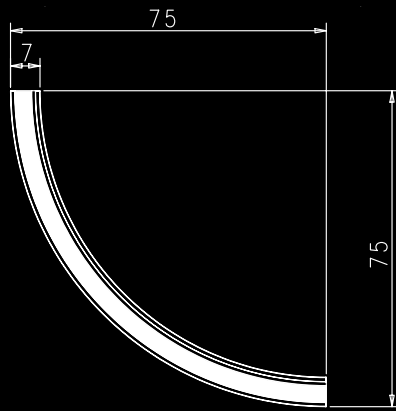
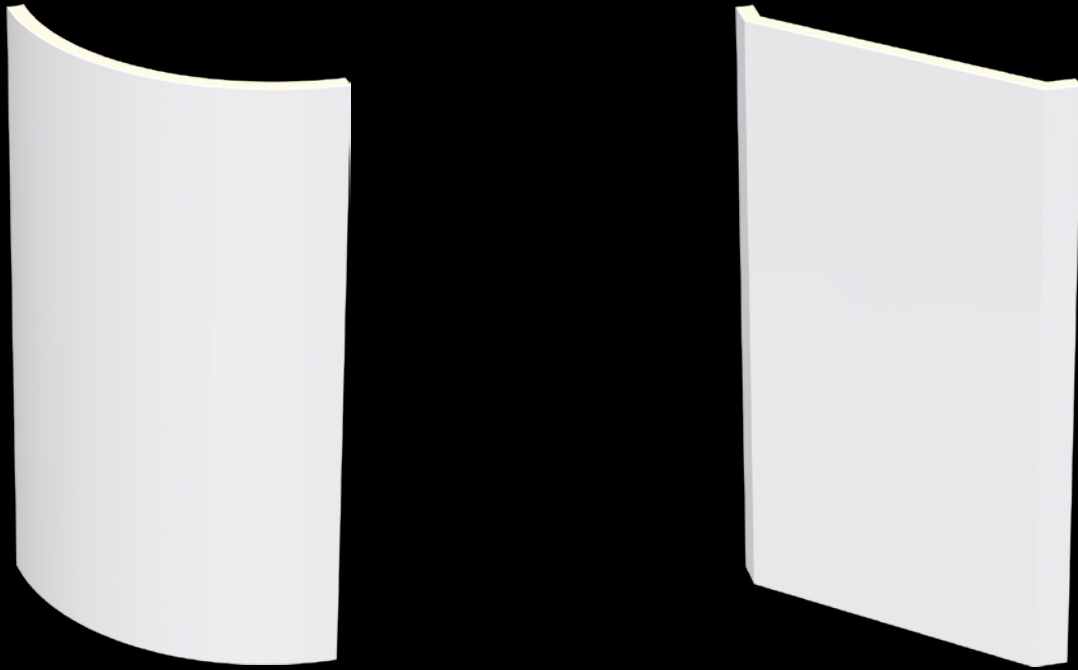

**PANNELLI SPECIALI SPESSORE 70 cm DISPONIBILI PER CELLE:**

Altezza con pavimento: 216, 236 e 256 cm  
 Altezza senza pavimento: 209, 229 e 249 cm

**70 cm THICK SPECIAL PANELS AVAILABLE FOR COLD ROOMS:**

Height with floor: 216, 236 and 256 cm  
 Height without floor: 209, 229 and 249 cm

**AUTOPORTANZA PANNELLI SOFFITTO  
 SELF SUPPORTANCE FOR CEILING PANELS**

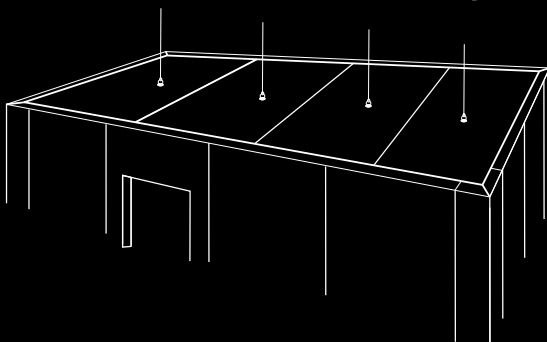

|                             |     |     |     |     |
|-----------------------------|-----|-----|-----|-----|
| Spessore<br>Thickness cm    | S7  | S10 | S12 | S15 |
| Lungh. Max<br>Max Length cm | 400 | 500 | 600 | 700 |

## SOLIDITA' E AFFIDABILITA' SENZA COMPROMESSI

L'aggancio diretto dei pannelli a parete con pavimento e soffitto senza utilizzo di colonnine verticali ed orizzontali, garantisce la massima solidità e robustezza della struttura. Questa soluzione permette al soffitto di essere portante in quanto appoggia direttamente sui pannelli a parete.

## SOLIDITY AND RELIABILITY WITHOUT COMPROMISE

The direct hooking of wall panels with floor and ceiling without using vertical and horizontal edge profiles grants maximum solidity and robustness to the structure. With such a solution, ceilings are supporting, as they lean directly on wall panels.

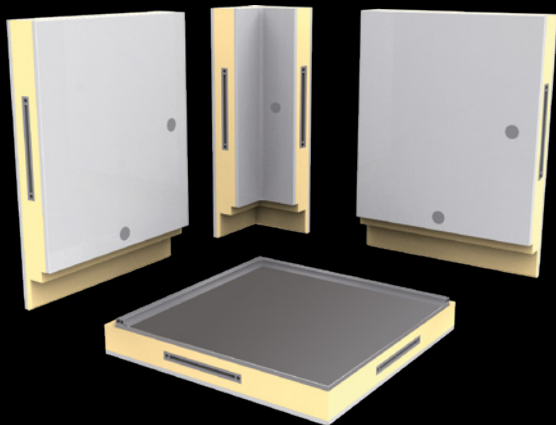

DIVISORIO FISSO con pannello a "T" e parete completamente "agganciata"

FIXED PARTITION with "T" panels and completely "hooked" wall.



DIVISORIO MOBILE non a modulo con fissaggio tramite profili in PVC.

MOBILE PARTITION non-modular, with fixing by PVC profiles.

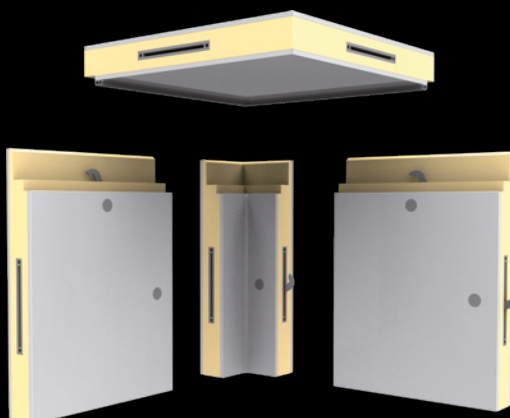

## SICUREZZA ED IGIENE

Rivestimenti interni ed esterni in lamiera zinco plastificata con certificazione alimentare. Spigoli interni arrotondati per facilitare la pulizia e garantire la massima igiene.

## SAFETY AND HYGIENE

Internal and external covering in food-grade plastic-coated galvanized sheet. Internal rounded corners for easy cleaning and maximum hygiene.



## ISOLAMENTO - INSULATION

|  |                            |        |        |        |
|--|----------------------------|--------|--------|--------|
| ISOLAMENTO PANNELLO<br>PANEL THICKNESS $C_m$                   | 7                          | 10     | 12     | 15     |
| Temperatura minima consigliata<br>Min. recommended temperature | -5 °C                      | -22 °C | -25 °C | -30 °C |
| Conduzione termica<br>Heat conduction K                        | 0,34                       | 0,24   | 0,20   | 0,16   |
| Densità<br>Density   | kg/m <sup>3</sup><br>40-42 |        |        |        |
| Conducibilità termica<br>Thermal conductivity                  | mW/m <sup>°K</sup><br>22,2 |        |        |        |
| Carico a compressione<br>Compression load                      | N/mm <sup>2</sup><br>0,20  |        |        |        |
| Reazione al fuoco<br>Reaction to fire                          | EN13501-1<br>B3            |        |        |        |
| Campo di applicazione<br>Application range                     | From -40°C to<br>+60°C     |        |        |        |
| HCFC o HFC<br>HCFC or HFC                                      | Esente - Free              |        |        |        |

## AGGANCI PANNELLI PANEL HOOKING

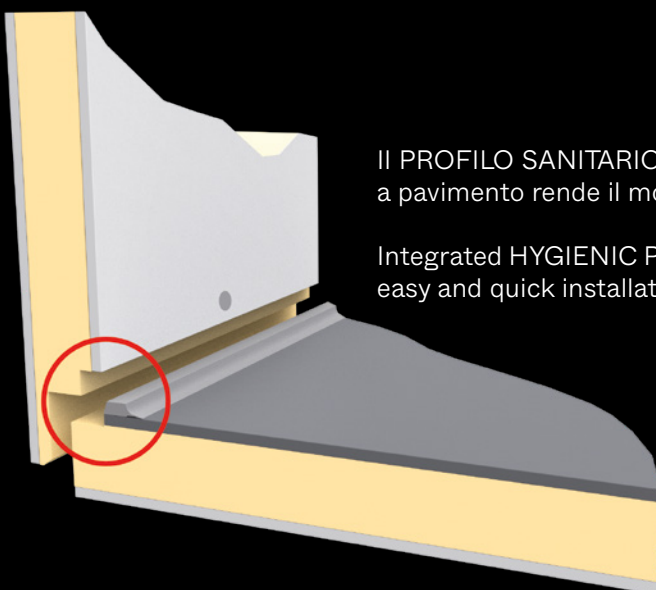
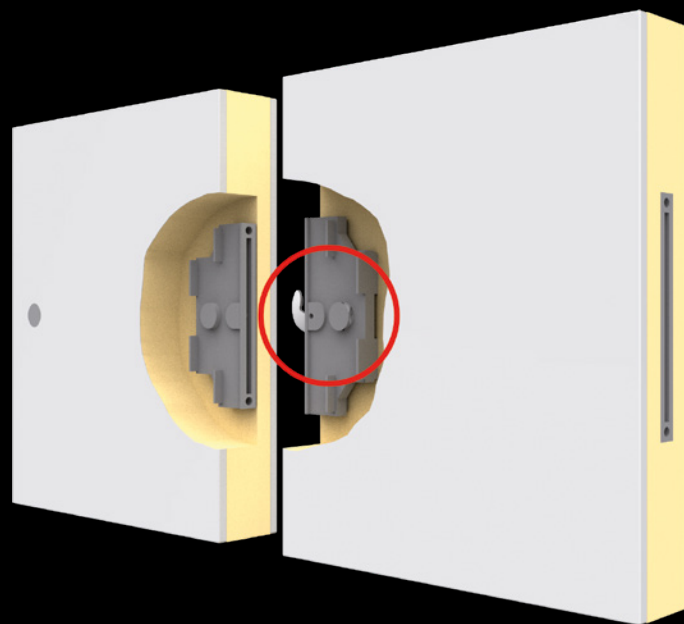

Il PROFILO SANITARIO integrato sui bordi dei pannelli a pavimento rende il montaggio facile e veloce.

Integrated HYGIENIC PROFILE on floor panel edges for easy and quick installation.

 **cold mark**  
INSULATED PANELS

 **FIXWELL**  
www.fixwell.com.hk

# PAVIMENTI - FLOORS

**(A)** Lamiera plastificata spessore 0,7 mm.  
Plastic-coated steel thickness 0,7 mm.

**(B)** Supporto in legno truciolare spessore 10 mm.  
Chipboard support, thickness 10 mm.

**(C)** Tappi di rinforzo posizionati ad alveare.  
Reinforcement spacers

**(D)** Alluminio mandorlato spessore 3 mm.  
Chequered aluminium, thickness 3 mm.

**(E)** Acciaio INOX AISI 304 antiscivolo spessore 0,6 mm.  
Non-slip AISI 304 stainless steel, thickness 0,6 mm.

**(F)** Resina fenolica spessore 10 mm.  
Phenolic resin, thickness 10 mm.

**(G)** Lamiera Zincata spessore 0,6 mm.  
Galvanized plate thickness 0,6 mm.

**(H)** Acciaio INOX AISI 304 antiscivolo R12 spessore 1,2 mm.  
R12 Non-slip AISI 304 stainless steel, thickness 1,2 mm.

## PAVIMENTO STANDARD ANTISCIVOLO R9 PEDONABILE

Carico statico max 2500 kg/mq uniformemente distribuito  
Carico concentrato 90 kg

## STANDARD NON-SLIP WALK-IN R9 FLOOR

Uniformly distributed static load max 2500 kg/sqm  
Concentrated load 90 kg

Mod: ST2500

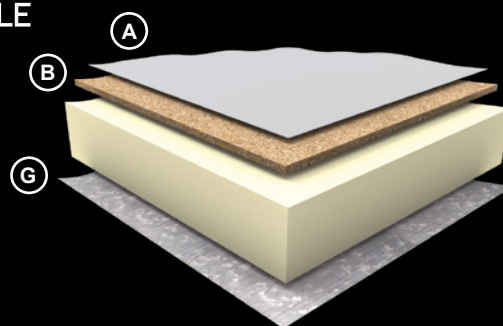

Max 2500 Kg/mq

Max 90 Kg

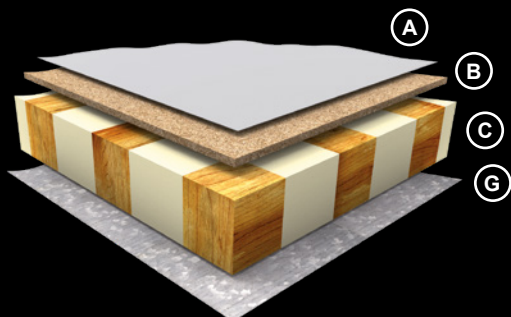

Max 90 Kg



Max 4000 Kg/mq



Max 140 Kg

## PAVIMENTO STANDARD RINFORZATO ANTISCIVOLO R9 CARRELLABILE

Carico statico max 4000 kg/mq uniformemente distribuito  
Carico dinamico max 90 kg per ruota con carrello dotato di ruote in gomma morbida con larghezza min. di 4 cm  
Carico concentrato 140 kg

## STANDARD NON-SLIP REINFORCED ROLL-IN R9 FLOOR

Uniformly distributed static load max 4000 kg/sqm  
Maximum dynamic load 90 kg per wheel for trolley with soft rubber wheels and 4 cm minimum width  
Concentrated load 140 kg

Mod: ST4000

## PAVIMENTO INOX ANTISCIVOLO PEDONABILE

Carico statico max 2500 kg/mq uniformemente distribuito  
Carico concentrato 90 kg

## NON-SLIP WALK-IN STAINLESS STEEL FLOOR

Uniformly distributed static load max 2500 kg/sqm  
Concentrated load 90

Mod: IN2500

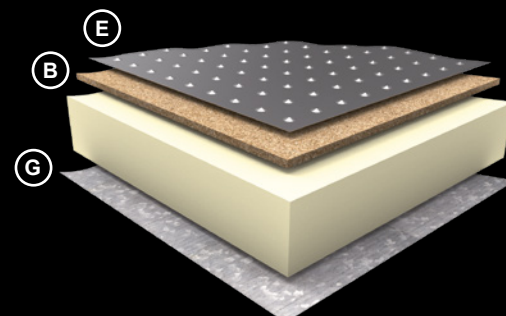

Max 2500 Kg/mq

Max 90 Kg

## PAVIMENTO INOX RINFORZATO ANTISCIVOLO CARRELLABILE

Carico statico max 4000 kg/mq uniformemente distribuito  
Carico dinamico max 90 kg per ruota con carrello dotato di ruote in gomma morbida con larghezza minima di 4 cm  
Carico concentrato 140 kg

## NON-SLIP REINFORCED ROLL-IN STAINLESS STEEL FLOOR

Uniformly distributed static load max 4000 kg/sqm  
Maximum dynamic load 90 kg per wheel for trolley with soft rubber wheels and 4 cm minimum width  
Concentrated load 140 kg

Mod: IN4000

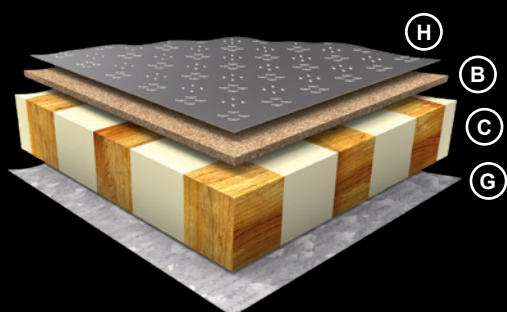

Max 90 Kg



Max 4000 Kg/mq



Max 140 Kg

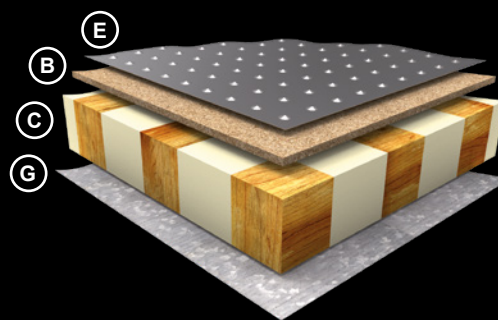

Max 90 Kg



Max 4000 Kg/mq



Max 140 Kg

## PAVIMENTO INOX EXTRA RINFORZATO ANTISCIVOLO R12 CARRELLABILE

Carico statico max 5000 kg/mq uniformemente distribuito  
Carico dinamico max 200 kg per ruota con carrello dotato di ruote in gomma morbida con larghezza minima di 4 cm  
Carico concentrato 200 kg

## ANTISLIP EXTRA REINFORCED ROLL-IN R12 STAINLESS STEEL FLOOR

Uniformly distributed static load max 5000 kg/sqm  
Maximum dynamic load 200 kg per wheel for trolley with soft rubber wheels and 4 cm minimum width  
Concentrated load 200 kg

Mod: IN5000

## PAVIMENTO IN ALLUMINIO MANDORLATO RINFORZATO ANTISCIVOLO Idoneo transito TRANSPALLET

Carico statico max 5000 kg/mq uniformemente distribuito  
Carico dinamico per transito transpallets con peso complessivo non superiore a 1500 kg  
Carico concentrato 200 kg

## NON-SLIP CHEQUERED ALUMINIUM REINFORCED FLOOR Suitable for PALLET JACK transit

Uniformly distributed static load max 5000 kg/sqm  
Dynamic load for pallet jacks with total weight up to 1500 kg  
Concentrated load 200 kg

Mod: AL1500

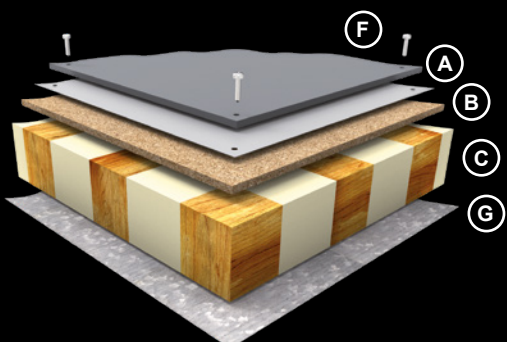

Max 2000 Kg



Max 5000 Kg/mq



Max 200 Kg

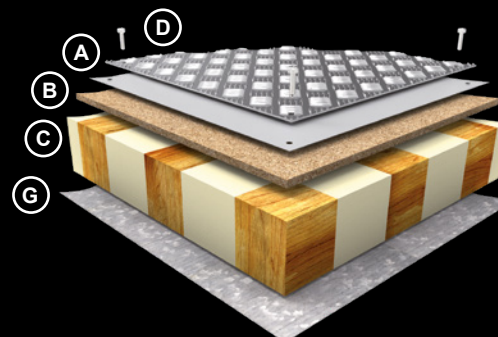

Max 1500 Kg



Max 5000 Kg/mq



Max 200 Kg

## PAVIMENTO RINFORZATO CON LASTRA DI RESINA FENOLICA ANTISCIVOLO CARRELLABILE

Carico statico max 5000 kg/mq uniformemente distribuito  
Carico dinamico per transito carrelli con peso complessivo non superiore a 2000 kg  
Carico concentrato 200 kg

## NON-SLIP PHENOLIC RESIN ROLL-IN PLATE REINFORCED FLOOR

Uniformly distributed static load max 5000 kg/sqm  
Dynamic load for trolleys with total weight up to 2000 kg  
Concentrated load 200 kg

Mod: RF2000

# MAXI CAB



## ARMADI FRIGORIFERI COMPONENTI

Montaggio rapido tramite ganci ad eccentrico  
Elevata capacità di stoccaggio  
Qualità e igienicità dei materiali  
Sempre disponibile a magazzino



## MODULAR REFRIGERATED CABINETS

Quick installation by eccentric hooks  
Great storage capacity  
Quality and hygiene in materials  
Always available on stock





 **cold mark**  
INSULATED PANELS

 **FIXWELL**  
www.fixwell.com.hk

### **DOTAZIONE STANDARD**

Cremagliera in acciaio inox  
Guide di supporto griglie o teglie (Optional)

### **STANDARD EQUIPMENT**

Stainless steel fitted rack  
Slideways for wire shelves or pans (Optional)

## CARATTERISTICHE TECNICHE

- Spessore pannelli 7 cm sia per temperatura positiva TN che per temperatura negativa BT
- Rivestimento interno/esterno in lamiera zinco-plasticata di colore bianco
- Angoli interni arrotondati
- Porte 61×177 h cm con chiusura a chiave
- Isolamento in poliuretano ecologico ad alta densità 40 - 42 Kg/m<sup>3</sup>
- Cremagliere interne per l'inserimento di guide per griglie o teglie pasticceria 40×60 o 60×80 cm
- Impianti frigoriferi ventilati a soffitto o remoti con quadro comandi digitale (a richiesta)

## TECHNICAL FEATURES

- Panel thickness 7 cm for both positive temperature TN and negative temperature BT
- Internal/external covering in white plastic-coated galvanized sheet
- Internal rounded corners
- Doors 61×170 h cm with key-lock
- Insulation by environment-friendly polyurethane with high density 40 - 42 Kg/m<sup>3</sup>
- Internal racks for insertion of slideways for 40×60 cm or 60×80 cm wire shelves and pastry pans
- Air-cooled ceiling-mounted or remote refrigerating systems with digital control panel on demand

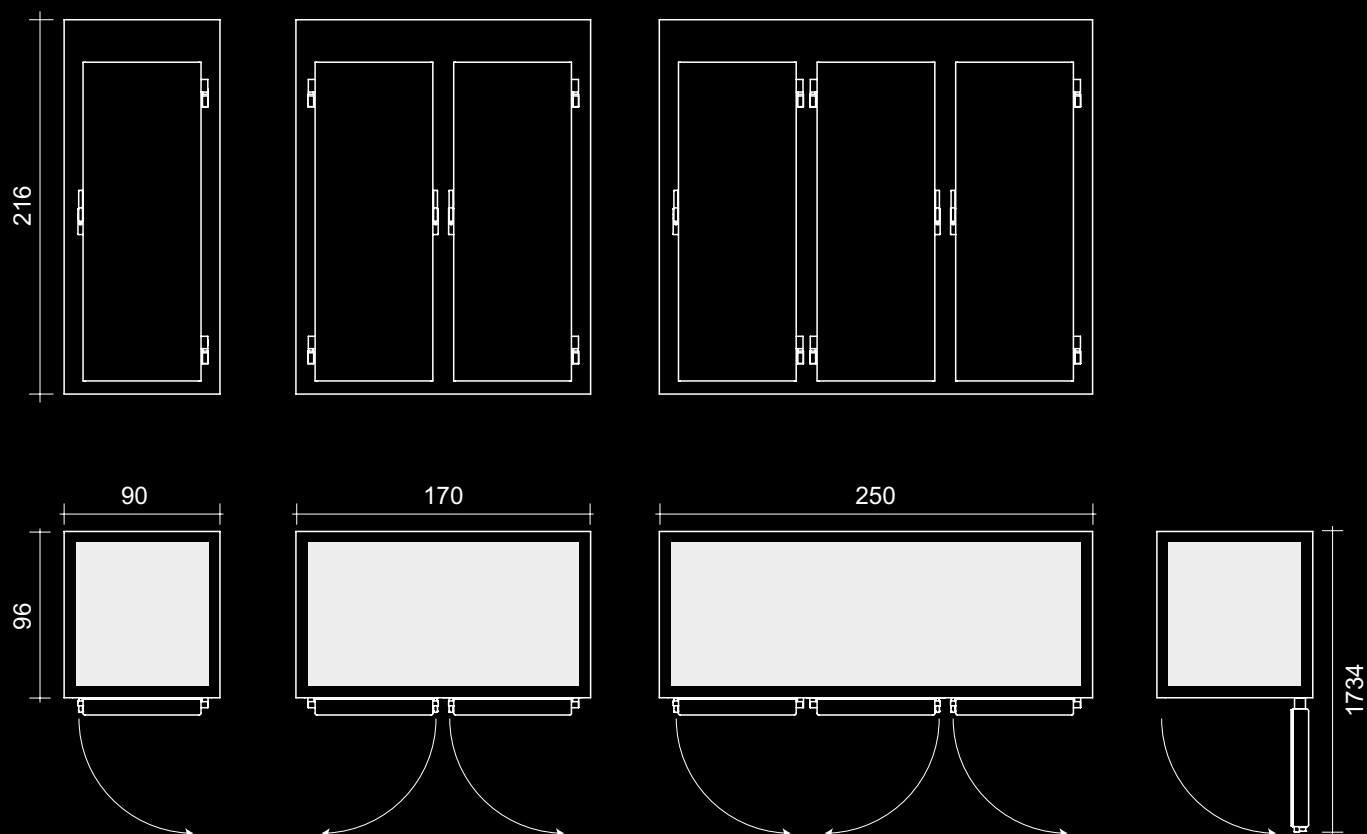

La "Cold Mark" si riserva il diritto di modificare le informazioni e le caratteristiche estetiche contenute in questo catalogo senza la necessità di alcun preavviso, poiché ritenute necessarie e opportune al miglioramento dei prodotti stessi, senza pregiudicarne le caratteristiche essenziali. Per le condizioni di vendita fare riferimento a quelle riportate sul sito [www.coldmark.it](http://www.coldmark.it) e/o sul Listino Prezzi in vigore.

"Cold Mark" reserves the right to change the data and aesthetic features of the products on this catalogue without any necessity of prior notice, since the modifications are deemed as necessary and suitable for the improvement of the products without compromising their essential features. Please refer to the sales conditions on our website [www.coldmark.it](http://www.coldmark.it) a/o on the Price List in force at the moment.

Hong Kong Distributor:



**FIXWELL DISPLAY SYSTEM CO, LTD**

Unit 1401, Westlands Centre,  
20 Westlands Road, Quarry Bay, Hong Kong.  
tel.: +852 2811 9381 | fax: +852 2565 7094  
e-mail: [sales@fixwell.com.hk](mailto:sales@fixwell.com.hk)  
website: [www.fixwell.com.hk](http://www.fixwell.com.hk)

Cold Mark

Via F.lli Cervi n°1  
46023 Palidano di Gonzaga (MN) — Italy  
T +39 0376 532029  
[coldmark@coldmark.it](mailto:coldmark@coldmark.it)  
[coldmark.it](http://coldmark.it)

